

Appendix B
Existing Pedestrian Traffic Counts

Wells & Associates, LLC
 McLean, Virginia



Pedestrian Volume Survey

Project Name: Square 54
 Project Number: 2762
 Location: Washington, DC
 Intersection: Washington Circle & 23rd St.-
 Weather: Clear
 Date: 5/11/2005
 Surveyor: Gary

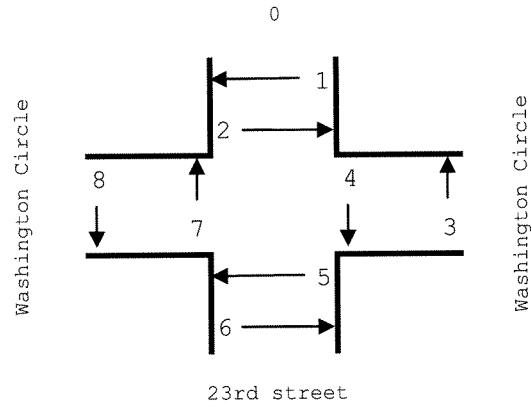

TIME	Movement							
	1	2	3	4	5	6	7	8
AM								
6:00-6:15					4	4		
6:15-6:30					3	6		
6:30-6:45					6	9		
6:45-7:00					15	32		
7:00-7:15					4	15		
7:15-7:30					2	25		
7:30-7:45					4	57		
7:45-8:00					18	62		
8:00-8:15					9	97		
8:15-8:30					13	111		
8:30-8:45					12	117		
8:45-9:00					12	133		
PM								
4:00-4:15					34	31		
4:15-4:30					47	74		
4:30-4:45					50	56		
4:45-5:00					14	16		
5:00-5:15					26	77		
5:15-5:30					43	78		
5:30-5:45					59	13		
5:45-6:00					49	13		
6:00-6:15					43	26		
6:15-6:30					50	30		
6:30-6:45					62	24		
6:45-7:00					20	22		



Pedestrian Volume Survey

Project Name: Square 54

Project Number: 2762

Location: Washington, DC

Intersection: Washington Circle & Penn.Ave.-

Weather: Clear

Date: 5/11/2005

Surveyor: Alba

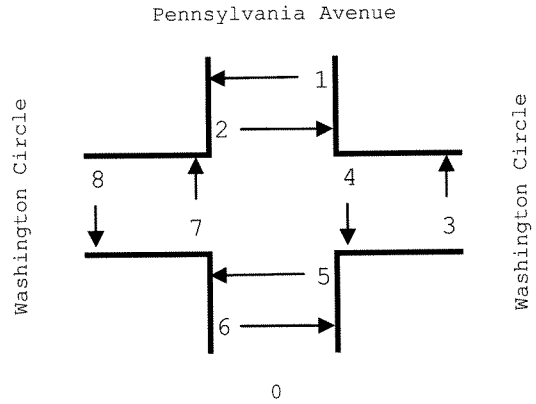

TIME	Movement							
	1	2	3	4	5	6	7	8
AM								
6:00-6:15	1			1	1	10		
6:15-6:30			3	1	1	9	3	2
6:30-6:45			3	2	10	12		
6:45-7:00			2	2	15	11	2	1
7:00-7:15			2	8	17	143	14	5
7:15-7:30			1	5	22	121		1
7:30-7:45			3	9	22	143		3
7:45-8:00			2	13	20	85	10	2
8:00-8:15		3	7	23	23	61		4
8:15-8:30	3	4	10	11	29	92	2	3
8:30-8:45	2		3	23	24	58	3	4
8:45-9:00	1	2	9	26	22	54	2	3
PM								
4:00-4:15					219	43	2	1
4:15-4:30		2			76	43	1	1
4:30-4:45					108	36		5
4:45-5:00					117	42	5	1
5:00-5:15					166	52		
5:15-5:30					108	37	3	1
5:30-5:45		1	3		135	36	3	2
5:45-6:00	31	4			182	37	1	5
6:00-6:15	4	3			162	35	1	
6:15-6:30	17	2			114	43	3	3
6:30-6:45	3	4			63	32	2	1
6:45-7:00	9	5			72	36	3	5



Pedestrian Volume Survey

Project Name: Square 54
 Project Number: 2762
 Location: Washington, DC
 Intersection: Washington Cir. & K Street
 Weather: Clear
 Date: 5/11/2005
 Surveyor: Luz

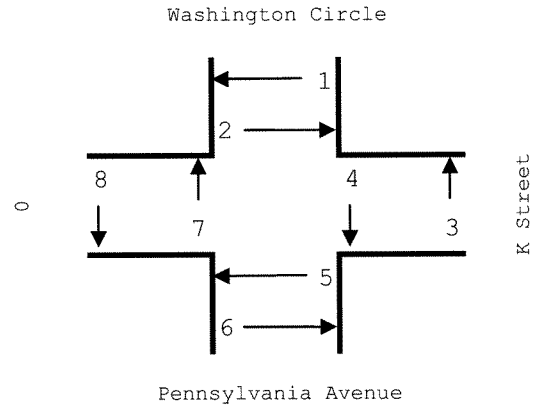

TIME	Movement							
	1	2	3	4	5	6	7	8
AM								
6:00-6:15	1		3	1	1			
6:15-6:30	1	2	3	1	1	1		
6:30-6:45	4	2	2	1	1	2		
6:45-7:00	2	6	2	2	1	2		
7:00-7:15	4	7	1	2	1	1		
7:15-7:30	3	4	3	8	1	5		
7:30-7:45	6	9	2	3	2	6		1
7:45-8:00	6	10	7	10	2	6		
8:00-8:15	5	7	9	15	3	8	1	1
8:15-8:30	8	10	9	21	2	4		
8:30-8:45	2	3	7	27	2	3	1	
8:45-9:00	7	9	7	28	3	6	1	
PM								
4:00-4:15	8	2	11	6	4	5		
4:15-4:30	9	3	12	11	1	6		
4:30-4:45	11	6	3	7	4	6		
4:45-5:00	6	7	6	9	10	2		2
5:00-5:15	7	8	11	11	6	3		
5:15-5:30	10	5	10	8	7	2		
5:30-5:45	10	3	12	6	14	5		
5:45-6:00	11	9	10	5	21	2		
6:00-6:15	17	7	8	9	15	5	1	
6:15-6:30	9	8	10	7	22	12	1	
6:30-6:45	19	9	18	14	21	10		
6:45-7:00	9	10	12	3	17	5		



Pedestrian Volume Survey

Project Name: Square 54
 Project Number: 2762
 Location: Washington, DC
 Intersection: Washington Cir. & New Hampshire
 Weather: Clear
 Date: 5/11/2005
 Surveyor: Lucia

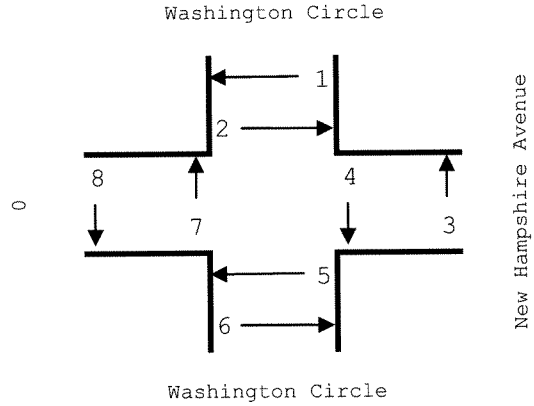

TIME	Movement							
	1	2	3	4	5	6	7	8
AM								
6:00-6:15	6	9	5	1		1		
6:15-6:30	5	6	4	2		1		
6:30-6:45	8	9	4	5				
6:45-7:00	12	12	3	12				
7:00-7:15	20	18	16	10	1			
7:15-7:30	12	25	10	23		2		
7:30-7:45	16	28	9	23		4		
7:45-8:00	19	37	12	40	3			
8:00-8:15	35	38	18	35	1	1		
8:15-8:30	49	33	22	53				
8:30-8:45	43	44	20	68				
8:45-9:00	38	46	12	69				
PM								
4:00-4:15	23	16	26	19				
4:15-4:30	30	21	25	17				
4:30-4:45	39	27	31	17				
4:45-5:00	25	21	27	16				
5:00-5:15	58	34	48	30				
5:15-5:30	41	33	42	29				
5:30-5:45	47	42	39	25				
5:45-6:00	40	27	49	12				
6:00-6:15	49	43	51	29				
6:15-6:30	34	48	41	24				
6:30-6:45	32	48	42	24				
6:45-7:00	34	25	33	17				



Pedestrian Volume Survey

Project Name: Square 54

Project Number: 2762

Location: Washington, DC

Intersection: Washington Circle & 23rd St.-

Weather: Clear

Date: 5/11/2005

Surveyor: Rolando

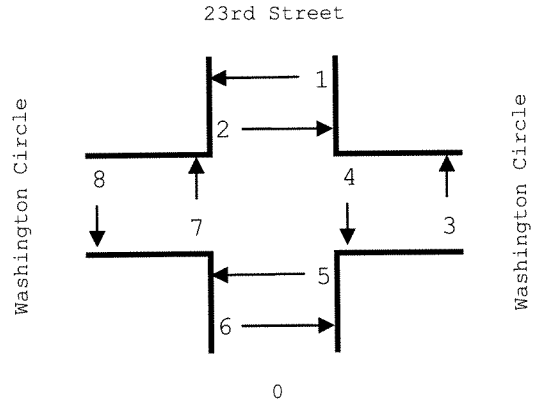

TIME	Movement							
	1	2	3	4	5	6	7	8
AM								
6:00-6:15	2		6					1
6:15-6:30	2	1	2	2			1	1
6:30-6:45	5	2	6				7	5
6:45-7:00	4	2	5	2			6	4
7:00-7:15	3	5	3				4	1
7:15-7:30	4	7	6	5			5	1
7:30-7:45	1	3	14	1				1
7:45-8:00	5	8	30	17				
8:00-8:15	12	15	24	6				1
8:15-8:30	9	25	34	8				
8:30-8:45	8	20	22	15				2
8:45-9:00	12	30	37	5				
PM								
4:00-4:15	13	16	13	18				
4:15-4:30	5	7	7	26				
4:30-4:45	15	17	7	40				
4:45-5:00	11	17	8	17				
5:00-5:15	14	15	3	42				
5:15-5:30	8	18	2	21				
5:30-5:45	11	14	5	19				
5:45-6:00	21	12	6	10				
6:00-6:15	31	4	14	14				
6:15-6:30	12	16	4	14				
6:30-6:45	10	11	5	8				
6:45-7:00	14	13	6	9				



Pedestrian Volume Survey

Project Name: Square 54

Project Number: 2762

Location: Washington, DC

Intersection: Washington Cir. & Pennsylvania

Weather: Clear

Date: 5/11/2005

Surveyor: Jorge

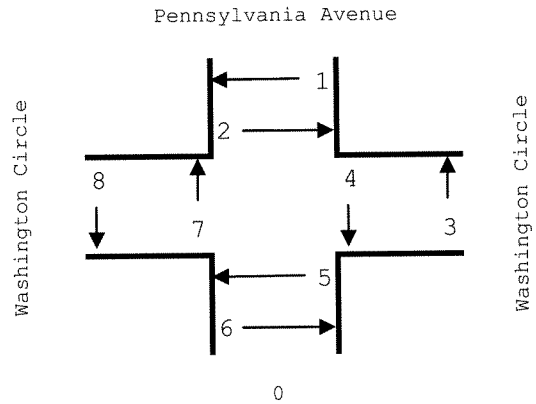

TIME	Movement							
	1	2	3	4	5	6	7	8
AM								
6:00-6:15	16	13	4	2	9	4	5	2
6:15-6:30	8	11	2	4	4	6	7	4
6:30-6:45	5	23	5	8	7	8	6	2
6:45-7:00	10	18	3	3	5	13	11	5
7:00-7:15	9	14	6	4	6	9	13	3
7:15-7:30	13	17	5	6	7	8	16	2
7:30-7:45	15	16	4	6	9	10	17	2
7:45-8:00	14	28	6	8	12	14	19	6
8:00-8:15	28	34	8	5	15	19	32	8
8:15-8:30	35	46	10	7	19	23	39	7
8:30-8:45	52	58	14	9	22	26	58	3
8:45-9:00	56	64	19	11	26	28	62	12
PM								
4:00-4:15	18	14	8	4	12	6	7	9
4:15-4:30	12	16	6	7	9	10	9	6
4:30-4:45	9	26	7	10	9	11	9	4
4:45-5:00	15	23	8	6	8	16	13	7
5:00-5:15	13	19	7	8	12	14	15	6
5:15-5:30	18	24	6	9	7	10	19	4
5:30-5:45	17	18	5	8	12	16	23	7
5:45-6:00	14	30	6	10	16	22	34	8
6:00-6:15	31	37	10	6	19	26	35	6
6:15-6:30	378	49	10	8	24	26	41	7
6:30-6:45	56	62	16	9	28	32	68	3
6:45-7:00	52	58	23	13	29	31	54	13



Pedestrian Volume Survey

Project Name: Square 54

Project Number: 2762

Location: Washington, DC

Intersection: Washington Cir. & K Street

Weather: Clear

Date: 5/11/2005

Surveyor: Milton & Majda

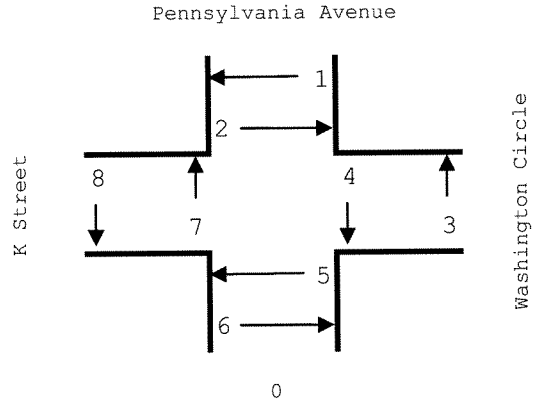

TIME	Movement							
	1	2	3	4	5	6	7	8
AM								
6:00-6:15	23	5	8	4	12	6		
6:15-6:30	12	10	7	10	8	8		
6:30-6:45	1	15	10	18	6	7		
6:45-7:00	16	18	3	20	13	10		
7:00-7:15	24	20	8	25	19	20		
7:15-7:30	26	39	5	28	18	15		
7:30-7:45	28	32	8	30	24	20		
7:45-8:00	30	38	10	30	16	12		
8:00-8:15	35	48	11	18	13	10		
8:15-8:30	70	36	12	15	10	11		
8:30-8:45	41	58	20	20	20	10		
8:45-9:00	58	70	24	18	25	13		
PM								
4:00-4:15	38	45	12	7	4	5		
4:15-4:30	42	37	7	6	6	2		
4:30-4:45	43	37	3	3	10	6		
4:45-5:00	40	32	5	5	2	9		
5:00-5:15	38	38	5	7	3	11		
5:15-5:30	48	42	8	7	4	5		
5:30-5:45	46	49	6	10	3	4		
5:45-6:00	42	46	7	8	6	6		
6:00-6:15	40	52	9	5	8	7		
6:15-6:30	58	42	15	9	3	2		
6:30-6:45	63	57	17	5	2	5		
6:45-7:00	75	50	19	2	2	1		

Wells & Associates, LLC
 McLean, Virginia



Pedestrian Volume Survey

Project Name: Square 54
 Project Number: 2762
 Location: Washington, DC
 Intersection: Washington Cir. & New Hampshire
 Weather: Clear
 Date: 5/11/2005
 Surveyor: Jonathan

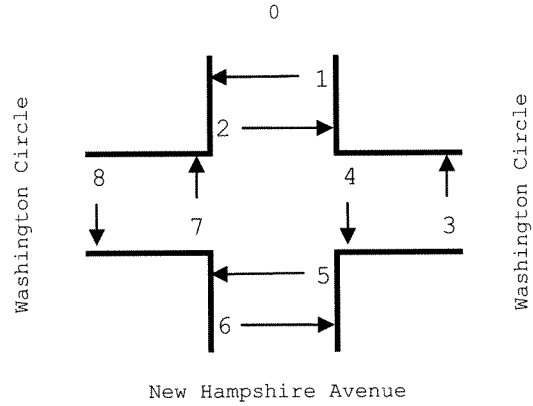

TIME	Movement							
	1	2	3	4	5	6	7	8
AM								
6:00-6:15			9	2	15	3	1	1
6:15-6:30			3	3	14	3		4
6:30-6:45			6	6	29	12	5	1
6:45-7:00			11	4	28	14	10	9
7:00-7:15			8	4	36	28	3	12
7:15-7:30			8	8	34	42	18	8
7:30-7:45			6	2	25	44	22	7
7:45-8:00			15	11	37	32	12	7
8:00-8:15			19	8	33	24	28	22
8:15-8:30			14	23	32	32	38	31
8:30-8:45			25	19	36	34	32	19
8:45-9:00			31	26	30	20	29	32
PM								
4:00-4:15				20	34	22	15	6
4:15-4:30			7	17	13	24	7	2
4:30-4:45				22	38	26	15	14
4:45-5:00			8	18	29	34	17	17
5:00-5:15			10	29	26	28	9	24
5:15-5:30			9	22	28	17	14	11
5:30-5:45			13	25	33	19	15	12
5:45-6:00			15	16	14	26	13	10
6:00-6:15			6	19	15	32	28	10
6:15-6:30			16	17	11	18	24	25
6:30-6:45			14	15	22	18	11	14
6:45-7:00			8	8	12	10	12	9



Pedestrian Volume Survey

Project Name: Square 54
 Project Number: 2762
 Location: Washington, DC
 Intersection: 23rd Street & I Street
 Weather: Clear
 Date: 5/11/2005
 Surveyor: Roberto, Jose & Leyla

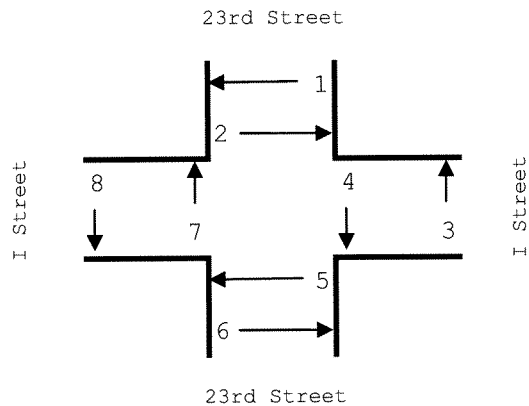

TIME	Movement							
	1	2	3	4	5	6	7	8
AM								
6:00-6:15	19	22	11	7	16	13	15	45
6:15-6:30	21	8	8	3	14	14	13	55
6:30-6:45	30	40	12	12	15	37	18	72
6:45-7:00	54	56	21	19	18	55	28	101
7:00-7:15	34	82	15	23	26	82	24	121
7:15-7:30	28	87	20	22	30	97	30	126
7:30-7:45	24	134	23	34	33	104	28	275
7:45-8:00	49	355	21	27	40	164	23	318
8:00-8:15	35	363	22	40	42	315	55	417
8:15-8:30	46	526	12	59	41	218	57	432
8:30-8:45	59	301	26	44	35	269	31	407
8:45-9:00	49	439	18	32	32	225	54	464
PM								
4:00-4:15	155	143	40	11	105	114	388	125
4:15-4:30	165	145	55	19	185	145	367	111
4:30-4:45	240	168	39	25	186	134	351	119
4:45-5:00	244	138	57	16	142	116	258	122
5:00-5:15	272	103	60	22	153	136	299	126
5:15-5:30	243	112	83	18	156	148	401	164
5:30-5:45	286	96	89	11	107	112	343	177
5:45-6:00	242	127	68	19	155	158	321	109
6:00-6:15	231	75	78	13	137	122	222	87
6:15-6:30	154	64	54	13	76	102	173	72
6:30-6:45	149	86	82	20	93	84	175	79
6:45-7:00	172	92	74	14	99	84	185	108



Pedestrian Volume Survey

Project Name: Square 54
 Project Number: 2762
 Location: Washington, DC
 Intersection: 22nd Street & I Street
 Weather: Clear
 Date: 5/11/2005
 Surveyor: Di & Shirley

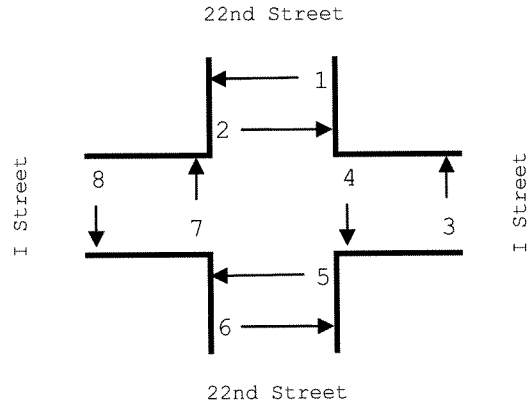

TIME	Movement							
	1	2	3	4	5	6	7	8
AM								
6:00-6:15	3	13	1	4	16	14	2	1
6:15-6:30		11	4	2	7	9	3	3
6:30-6:45	2	22	2	8	18	12	4	3
6:45-7:00	4	38	4	2	15	49	4	1
7:00-7:15	6	37	2	2	11	41	3	1
7:15-7:30	5	39	2	6	14	46	4	3
7:30-7:45	7	59	9	3	16	73	6	3
7:45-8:00	19	143	14	12	18	121	10	6
8:00-8:15	9	111	6	9	11	101	7	8
8:15-8:30	21	189	4	11	16	198	12	12
8:30-8:45	29	134	13	7	17	184	11	14
8:45-9:00	19	140	7	6	20	130	12	10
PM								
4:00-4:15	54	33	12	10	114	76	8	9
4:15-4:30	68	28	10	7	121	45	9	4
4:30-4:45	63	27	14	12	113	53	10	7
4:45-5:00	56	31	11	9	122	82	7	11
5:00-5:15	86	24	8	9	131	62	11	8
5:15-5:30	83	27	11	10	114	57	9	5
5:30-5:45	94	27	13	7	101	49	12	7
5:45-6:00	72	23	11	12	97	48	11	6
6:00-6:15	69	32	7	16	89	62	15	9
6:15-6:30	58	21	23	10	82	48	12	11
6:30-6:45	53	24	17	12	76	48	14	7
6:45-7:00	54	17	18	9	82	44	11	5



Pedestrian Volume Survey

Project Name: Square 54

Project Number: 2762

Location: Washington, DC

Intersection: Virginia Ave. & 22nd St.

Weather: Clear

Date: 5/11/2005

Surveyor: Gina & GiVanna

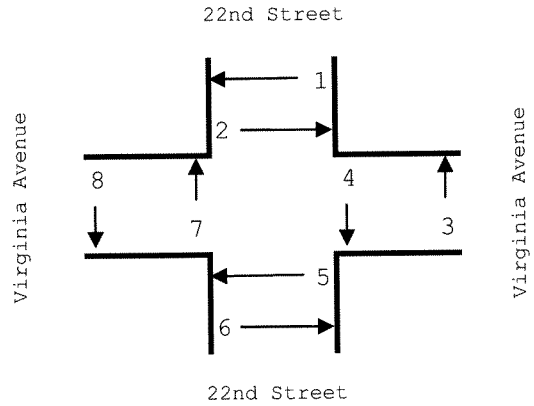

TIME	Movement							
	1	2	3	4	5	6	7	8
AM								
6:00-6:15		3	1	2	1	3		
6:15-6:30	1		3		1	9		
6:30-6:45	4	4		3	3	13		
6:45-7:00	1	6	5	8	2	11		
7:00-7:15	3	9	5	2	1	14		
7:15-7:30		11	11	9	2	18		
7:30-7:45		14	6	8	3	23		
7:45-8:00	3	16	12	12	4	19		
8:00-8:15	5	17	16	13	6	14		
8:15-8:30	6	13	25	14	7	12		
8:30-8:45	3	15	30	14	5	8		
8:45-9:00	8	13	12	11	4	6		
PM								
4:00-4:15	14	4	5	11	11	7		
4:15-4:30	17	10	6	13	14	9		
4:30-4:45	30	3	12	18	16	10		
4:45-5:00	24	5	5	26	18	11		
5:00-5:15	30	8	10	25	11	19		
5:15-5:30	23	6	11	18	21	28		
5:30-5:45	21	3	8	19	24	22		
5:45-6:00	18	4	7	20	11	18		
6:00-6:15	25	6	4	4	13	14		
6:15-6:30	17	10	5	3	12	11		
6:30-6:45	20	3	4	10	14	8		
6:45-7:00	9	5	1	2	9	6		

Wells & Associates, LLC
 McLean, Virginia



Pedestrian Volume Survey

Project Name: Square 54
 Project Number: 2762
 Location: Washington, DC
 Intersection: Virginia Ave. & 23rd Street
 Weather: Clear
 Date: 5/11/2005
 Surveyor: Al & Gerri

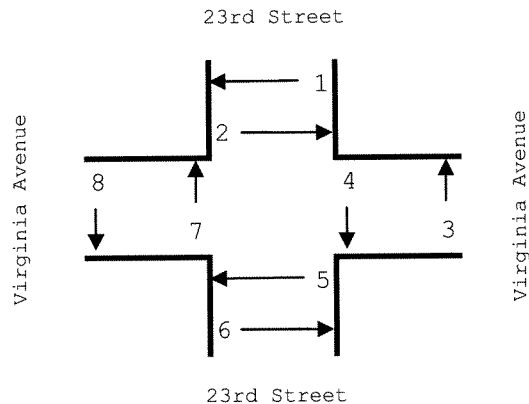

TIME	Movement							
	1	2	3	4	5	6	7	8
AM								
6:00-6:15	11		5	7	2	12	2	14
6:15-6:30	1	3	1	14	5	9	4	20
6:30-6:45	3	5	2	21	5	6	6	30
6:45-7:00	1	2	5	39	3	15	1	46
7:00-7:15	3	5	2	35	6	6	8	55
7:15-7:30	1	14	4	52	4	19	4	58
7:30-7:45	3	22	1	66	3	21	11	70
7:45-8:00	4	29	4	86	9	30	12	89
8:00-8:15	7	27	9	146	6	40	23	107
8:15-8:30	4	43	5	112	5	43	18	112
8:30-8:45	6	33	8	100	6	40	12	71
8:45-9:00	6	11	10	57	11	37	13	48
PM								
4:00-4:15	19	16	22	7	18	10	90	20
4:15-4:30	11	7	8	3	3		42	6
4:30-4:45	30	21	40	10	18	1	52	15
4:45-5:00	32	28	44	11	6	1	89	29
5:00-5:15	35	48	87	18	30	2	151	21
5:15-5:30	34	28	85	8	38	7	101	30
5:30-5:45	44	28	76	21	41	6	96	39
5:45-6:00	27	17	76	21	73	10	149	79
6:00-6:15	28	23	77	18	18	3	74	46
6:15-6:30	26	23	50	19	16	2	39	44
6:30-6:45	33	22	47	12	9	3	49	35
6:45-7:00	28	32	43	17	20	5	58	48